

PARALELKENAR- ÜÇGEN

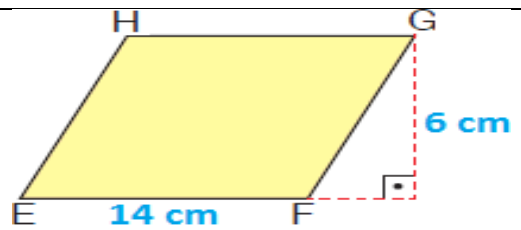

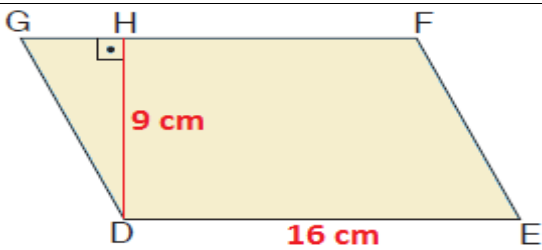

Δ A(ABC) kaç cm^2 dir?

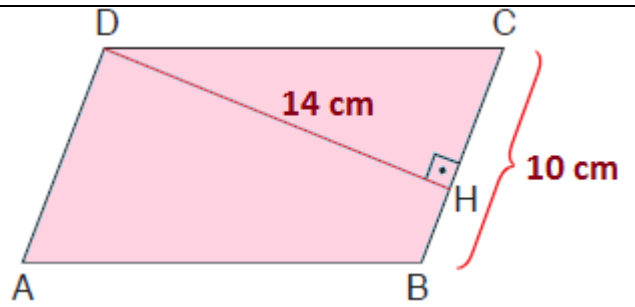
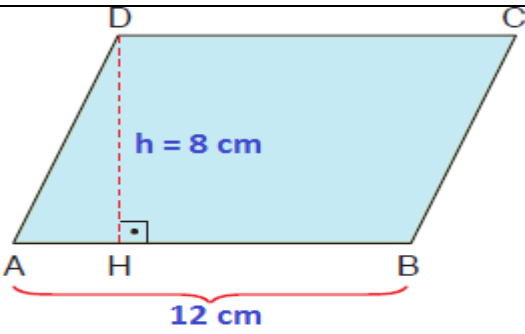
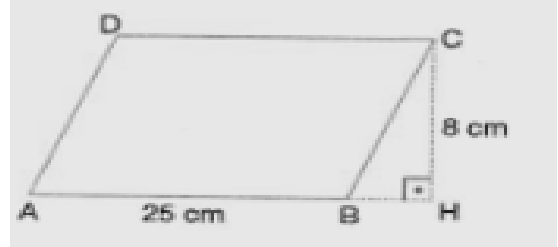
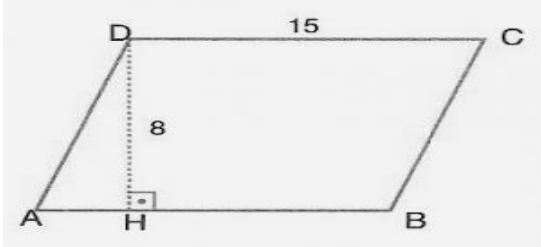
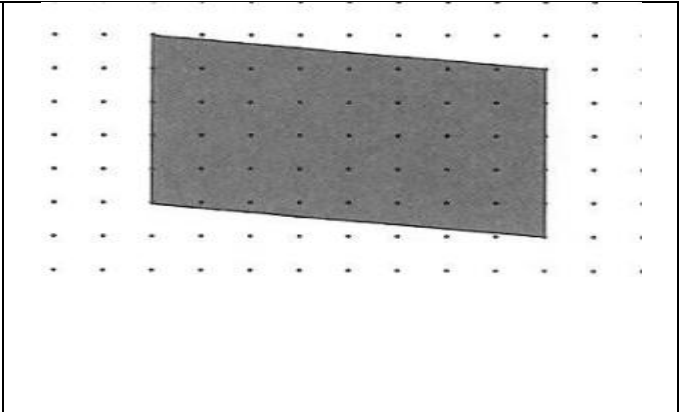
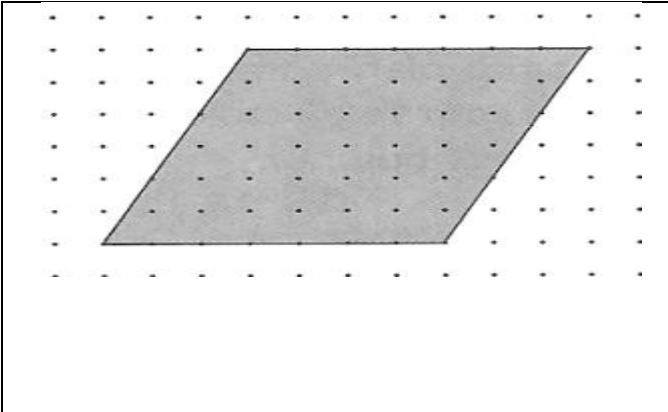
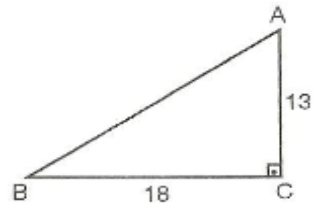
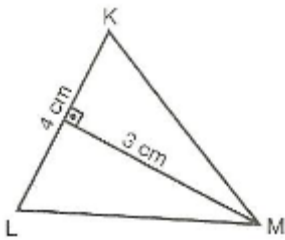
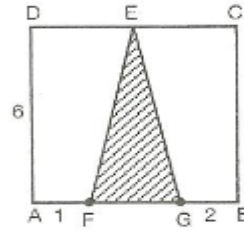
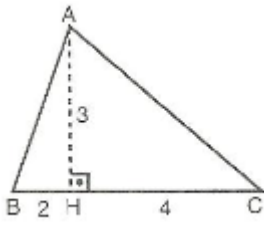
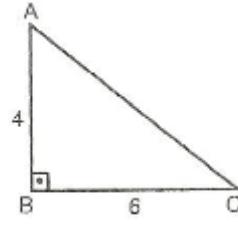
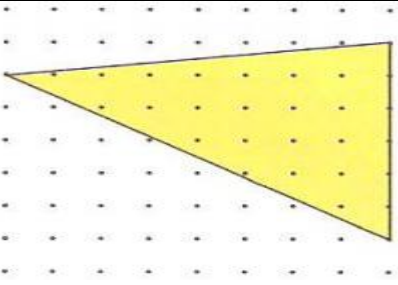
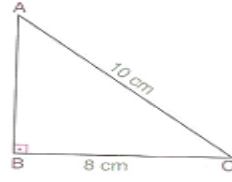
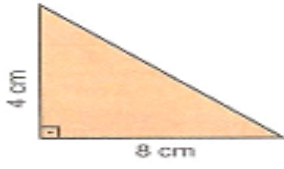